

THE MERTON GROUP

Municipal Broadband Network

Engineering Analysis

TOWN OF PETERBOROUGH , NH

September 2003

By

The Merton Group, LLC

© Merton Group, LLC, 2004, all rights reserved.

CONTENTS

1. Executive Summary.....	4
1.1 Objectives.....	4
1.2 Services Offered.....	4
1.3 Design Process.....	5
2. Introduction.....	7
3. Broadband.....	8
3.1 Broadband Goals.....	8
3.1.1 Economic Development.....	8
3.1.2 Local Participation and Communications.....	8
3.2 The Internet as an Example.....	9
3.3 Broadband Characteristics.....	10
3.3.1 Localism.....	10
3.3.2 Openness.....	10
3.3.3 Connectivity.....	10
3.3.4 Minimalism.....	10
4. MBN and Broadband Technologies.....	11
4.1 Benefits of MBN to the Municipality.....	11
4.2 Practical Considerations.....	12
4.3 The Network and Infrastructure.....	12
4.3.1 Local Network Interconnection.....	12
4.3.2 Local Open Networks.....	13
4.3.3 Interconnected Open Networks.....	14
4.4 Service Providers and Services.....	15
5. Network Layout.....	17
5.1 Design Constraints.....	17
5.2 Design Inputs.....	17
5.3 Design Performance Issues.....	18
5.4 Design Methodology.....	19
6. Analysis of Plant Build.....	20
6.1 Methodology.....	20
6.1.1 Headend.....	20
6.1.2 Network Elements.....	20
6.1.3 Sectorizing.....	21
6.1.4 Network Layout.....	21
6.2 Results.....	22
6.2.1 Sector Design.....	22
6.2.2 Basic Network Build Data Analysis.....	23
6.2.3 Setback.....	24
6.2.4 Frontage.....	24
6.2.5 Make Ready.....	25
6.2.6 Aerial.....	25
7. System Design.....	26
7.1 System Elements.....	26
7.2 Broadband Network Architecture.....	26
7.2.1 Popular Broadband Network Designs.....	27
7.3 PON vs. Gigabit Ethernet.....	30
7.3.1 Protocols.....	30
7.3.2 Interconnectivity.....	32
8. Capital Plant Estimates.....	35
8.1 Fiber Network Costs.....	35
8.2 Electronic Costs.....	35

8.3 Capital Summary 35
9. Field Data 37
10. Detailed Field Photos 39

1. EXECUTIVE SUMMARY

This report is a preliminary engineering analysis of the plant build for Peterborough , NH. It is based upon an analysis of the Town based upon direct analysis of the network size, demand, layout for coverage, and performance.

The analysis is also based upon detailed field measurements, which are contained in detail herein. The analysis is NOT the final analysis of the cost to build, it is a Planning analysis based upon the field engineering data. The main purpose of this report is to provide a review mechanism for the overall plan.

1.1 Objectives

This report will be used as a part of the overall Feasibility Study to be undertaken by Merton. The objectives of this report are as follows:

1. Establish the key design factors for the deployment of the MBN.
2. Determine the detailed design elements and do so in a fashion, which uses actual field measurements.
3. Develop a baseline network build plan for the town.
4. Perform a detailed analysis of the town and the elements, which will be part of the build plan. This includes the development of a data base of images of the key deployment elements, including; pole make ready issues, percent aerial, set back distances per HH, and frontage per HH.
5. Use the detailed results to develop as preliminary design.
6. Using the preliminary design, develop a capital estimating model for the network

These elements have been accomplished and are contained herein.

1.2 Services Offered

There are a wide variety of services that can be deployed. The first focus is Internet access. However, video such as cable TV, telephony, emergency signaling, meter reading, medical monitoring, library access, enhanced school, services are just a few extra. The local broadband system may provide, at a minimum, the following general services:

Voice: The system may provide toll grade quality voice service. The voice quality must be telephone toll grade or better and there may be no delays in speech that are perceptible to the user. The telephony service may be IP based voice or any other “toll grade” acceptable voice technology.

Very Low Speed Data: This service is 100 bps to 50 Kbps types of service and may be used for such applications as meter reading and other types of services which require low speed, polling, or other similar techniques. This may include such services as meter reading and the like.

Low Speed Data: The system may be able to provide data at the rates of 1.5 Mbps to 10 Mbps on a transparent basis and have this data stream integrated into the overall network fabric.

Medium Speed Data: The network may be able to handle medium speed data ranging from 10 Mbps to 100 Mbps.

High Speed Data: Data rates at and in excess of 100 Mbps and frequently in excess of 1 Gbps may also be provided on an as needed basis and a dedicated basis. The data rates may be between 1 Gbps and a maximum of 10 Gbps. Included in this class would be any and all municipal support service provided on a intra-net network.

Video: The network may be able to provide the user with access to analog and digitized video services. This may also enable the provisioning of interactive video services. This would also support High Definition TV (HDTV). The video service should be capable of supporting both analog and digital video distribution. The video services would be analog and digital video, video on demand, HDTV and other video premium services.

Wireless: The services considered here are the application of an integrated WiFi type network using a strand or more of the trunk and feeder fibers. This would be a fully integrated service platform providing 802.11, 802.16, or like type services.

Cellular Support: This is a service which allows cellular carriers to have capacity and coverage expansion using the fiber trunks and feeder networks. It would deploy a distributed cell site technology and again would be fully integrated from an operational perspective.

Other Wireless: This service would entail any other wireless access capability for the access to and from the end users.

Dark Fiber Services: These services would be a compilation of any and all potential uses of the dark fiber for commercial applications.

1.3 Design Process

The actual process used in the development of the engineering analysis is shown in the following graphic which is further detailed in this report.

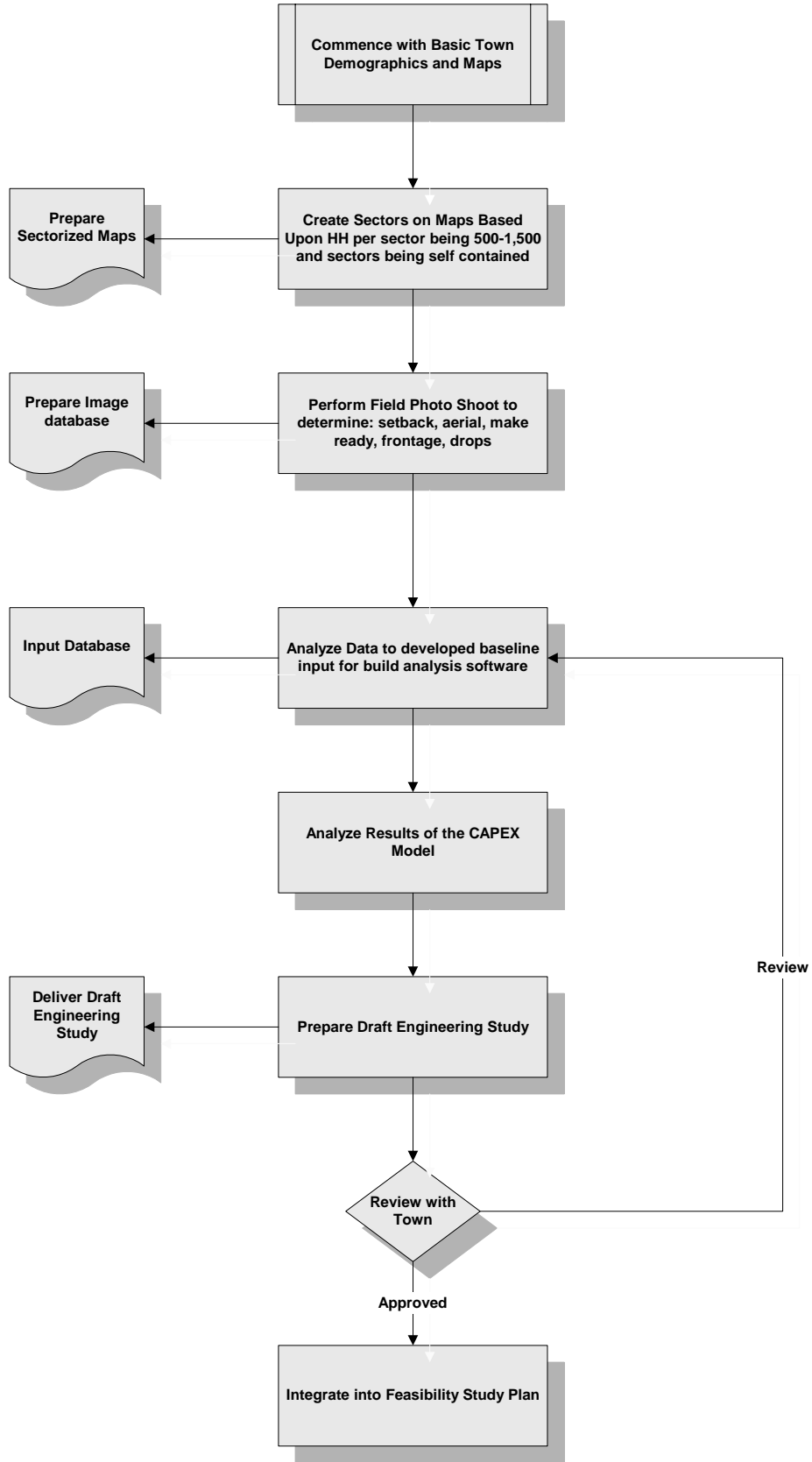

2. INTRODUCTION

Broadband is evolving into a credible and achievable technological deployment which is anticipated to have significant social and economic benefits. The current mode of evolution is one driven by local networks. Each network was considered as a closed island of communications capability. The current state of deployment now begin to consider regional, state, and possible national deployment. This next stage requires a bit of thought to ensure that what is achieved has the capabilities of a truly open broadband network. This will be the only way in which both the economic and social benefits may be achieved.

This paper addresses broadband from the perspective of the local deployment. The overriding principle of this analysis is to ensure a fully open and scaleable and integratable network, one that empowers both economic and social development. This calls for a set of overall criteria and a means to allow those criteria to take hold.

In the initial development of the Internet, the U.S. Advanced Research Projects Agency, AREA, set the base for commonality and openness. Following that IETF, the Internet Engineering Task Force, was a brilliant and effective colloquium that provided a truly evolutionary like stands process, what work survived, what did not disappeared. The same paradigm of establishing an agreement in a survival of the fittest mode is called upon for local broadband as well.

The development of infrastructure for municipalities has been shown time over time to be the basis for significant economic development of the municipality as well as enhancing the services available to the members of the community. Infrastructures such as schools, roads, water and sewer, power systems have been typical examples. The current development of broadband communications services, driven by Internet access and related services, is the current example of such a new infrastructure. This Proposal suggests that Fleet look at the viability of developing broadband infrastructure in low income and minority municipalities as the key next step in expanding the economic infrastructure.

The current typical positioning of broadband is that it can do what telephony and CATV can do today but "better, faster, and cheaper". This is what we call the double triple play; three services with three elements of improvement. In fact, as one explores the market and listens to what the users are rally saying, they see broadband as having two key elements; openness and localism. Neither of these two factors relate to the standard elements proposed nor do they relate to the characteristics of those elements. Openness means that the network allows any user to communicate with any and all other users. It further means a minimalism of implementation of broadband, as it is with the Internet, and an ability to move all of the intelligence and creativity to the edge of the network, in the hands of the user. Localism is a similar characteristic. Localism means that the power to create is left in the hands of the user. It is the complement of openness, which is the network looking outward. Localism is the complement of the network looking inwards. This paper describes how one can view broadband not just as a local or regional embodiment of openness and localism, but how it can play as both a national and international fabric for these concepts.

3. BROADBAND

What is broadband? Is it 200 Kbps, more, 1 Mbps, or more, 10 Mbps or more? In our definition, broadband is:

1. 10/100 BT connections to each user at a minimum with a 10+ Gbps backbone locally. It is also growable and scaleable. It would allow direct connection with backbone speeds.
2. An Open network, allowing any user to connect to any other user, at zero marginal cost. It is an outlet or portal.
3. Fully interconnected regionally and ultimately nationally. It is a network which allows local to local interconnection. It is not an island network, allowing only interconnection via proprietary and hierarchical points of entry.
4. An Open network allowing any purveyor of services to connect in any manner and any place to any user. It is a network which creates an electronic open and competitive marketing and distribution channel.

Interconnectivity and opens are key elements as are key factors as is the ability to have an expandable and scaleable network. A mere fifteen years ago there were discussions on bringing TCP/IP up to the speed of DS3 or 45 Mbps network. It was thought at the time that such a high speed would be prohibitive. In fact it has scaled way beyond that. Moreover the same was felt to be true about the scalability of Ethernet, limited to 10 Mbps, but now scaleable to 10 Gbps and beyond.

3.1 *Broadband Goals*

There must be a established set of goals for the deployment of broadband. We mention here a few. Many more will evolve as we better understand the functions of a truly broadband network.

3.1.1 *Economic Development*

The broadband environment, if aligned with an open network affording localism can become a Petri dish for the development of new services and technologies. It further can become a new marketing and distribution channel. This factor is of significant merit. For example, the Internet, at the lower speed, has limited abilities of promotion and persuasion. It to state it simply, lacks the human touch. It is like going to a bazaar in Istanbul with just pictures and price tags, no smells, no human interaction, no facilitation of the sales process. It is a “here it and this is the price”. Rather is empowers the promoter of the sales to do that promotion, to interact in a manner consistent with human communications, a communications demanding a true broadband communications channel. It must include voice, image, interaction, and facilitation so that parties can reach a better common understanding.

3.1.2 *Local Participation and Communications*

The local broadband network is akin to local roads, power, and other utilities. It becomes an integrated elements of the community.

3.2 *The Internet as an Example*¹

Why has the Internet been so successful? Much of the answer lies in unique design principles and features, which have led to a uniquely global, open, innovative network. Indeed, the Internet is different than most if not all communications systems of the past 150 years. Fundamentally it is a system that has been developed from the outside inwards, and that has afforded end-users the freedom to innovate at the edges to the utmost degree. This unique freedom afforded the users of this network has been the seminal elements in the Internet's ability to offer a rapidly changing environment. These principles and features distinguish the Internet from other parts of the information infrastructure such as today's Public Switched Telecommunications Network (PSTN).

Some of the unique design features include:

1. *"Hourglass" architecture.* The Internet can operate over different, changing underlying technologies, and applications are free to evolve above the transport layer. In this architecture, bits are bits and the network does not optimize for any class of applications.
2. *Interconnectivity.* If I connect anywhere, I have access everywhere. There are no segregated communities: all networks are interconnected and share the same address and name spaces.
3. *Unique names and addresses.* The Internet has adopted a single set of unique addresses which permit any connected device to communicate with any other. A common, unique set of names, which are mapped into addresses through a name service, allows each device to be uniquely identified.
4. *Easy many-to-many transmission via packet addressing.* The Internet is drastically different from the traditional hierarchical and one to one telecommunications services. It is a packet system, allowing control and enhancement at the periphery of the network and allowing for the "broadcasting" of packet to many destinations simultaneously. In many ways the Internet is the blending of characteristics peculiar to telephony and broadcast.
5. *Innovation takes place at the edge, through open interfaces.* The Internet is highly creative and innovative. This is because the point of innovation is at the edge of the network, through software running on devices connected to the network. Because of the hourglass architecture, the interface used by edge devices is standardized and open to all. Placing the intelligence at the ends permits rapid change (e.g., by adding new devices or loading new software into existing devices) that do not have to wait for changes or investment in the network infrastructure.
6. *Scalability.* Design with scalability in mind and strong architecture supervision guarantees future evolution. This is particularly important for "infrastructure" applications (a.k.a. middleware) and is guaranteed, today, by the open discussions in the IETF standard process.
7. *Distributed and Adaptive.* The Internet is more distributed and adaptive than other information networks. The Internet Protocol (IP) enables distributed control of the network except for the assignment of the highest level of addresses and Domain Name System (DNS) names. This distributed control provides for more rapid development and introduction of innovative applications and services.
8. *Quality-of-Service (QOS) harder to provide.* As noted above the Internet is more distributed and adaptive but more difficult to control if a given level of QOS is to be achieved. In the PSTN traffic congestion is managed such that under overloads connections may not be made. In the Internet originating traffic will access the destination endpoint and receive some level of service even though that service level may not be useful – referred to as "best effort". Thus, certain applications, e.g., voice or video, may be restricted in their use unless service management capabilities are introduced to ensure acceptable

¹ From "The Internet Coming of Age" National Academy of Science, 2001.

performance levels. And, although higher-priced high-speed links may be made available, there is no guarantee that the unmanaged core of the network will provide high-speed throughput.

3.3 Broadband Characteristics

There are certain characteristics which broadband must adhere, like those of the Internet as discussed above, to if it is going to achieve its full potential. Most of these characteristics have been learned from the steps we have taken with the development of the internet over the past twenty years.

3.3.1 Localism

Localism is a key concept at the MBN level. Localism means a participatory process driven by some form of co-ownership in the MBN. The participatory process and the ownership issue go hand in hand. The ownership may mean nothing more than a seat at the table with guarantees of openness. The participatory process demands an ability to allow those with vested interest to have their voices heard. Localism also means that there can be a focusing of the interactions and communications on a local level.

The major observation here is that as little as five years ago 95% or more of Internet traffic went to MAE East or West and then back again. Thus Europe communicated with web sites in the US and then back. India had over 99% of its traffic sent back and forth to the US. This has changed. Poland talks to Poland more than 50% of the time, France to France in excess of 70% of the time, and now India has over 70% of its Internet traffic to and from itself. Localism thus has a second dimension of internal communications and facilitating the process as well.

3.3.2 Openness

Openness is a powerful concept. It means that there is no proprietary control, that anyone may interconnect via a portal and that peer to peer communications is readily achievable. Moreover, openness means that anyone wanting commercial access can gain that access in a standard and predictable fashion.

Openness further implies an open and free flow of communications on both a global and local landscape. The localism element must become an integral part of openness.

3.3.3 Connectivity

Connectivity means allowing the networks to build and connect to one another. By having a minimalist connection criteria, a standard accepted by all, then connectivity can be achieved. Connectivity also demands that the local networks must agree to connect. The connection must also be done on a peer to peer basis with no economic limitations or fees. It is critical to eliminate the current transit fee construct which the Tier 1 Internet backbone carriers have which make for prohibitively costly interconnection to other networks.

The agreement to connect, local, open networks, then will circumvent the strangle hold of the Tier 1 Internet carriers. It will create a collection of locally interconnected open networks which will aggregate to a national and possible global open broadband infrastructure.

3.3.4 Minimalism

Minimalism is the essence of the Internet. The Internet is not the telephone networks of the past. The use of TCP/IP creates a minimalist schema for interconnecting, for expanding, and for achieving scale. This is the hour glass construct. Keep the internal simple, move the intelligence to the edge of the network where innovation is easily handled.

4. MBN AND BROADBAND TECHNOLOGIES

A Municipal Broadband Network² (MBN) is best characterized as Fiber to the Home (FTTH) providing 100 Mbps capacity or higher to the home or local business, open to all service providers, but financed and controlled by the municipality. This type of network is uniquely different from the current DSL or cable modem networks, which use older technologies. DSL utilizes copper wires, or “twisted pair”. The technology of copper wires dates to before the founding of the Bell System by Alexander Graham Bell in 1875, actually originating with the telegraph. The physical attributes of the copper medium severely limit both speed as well as range of broadband capabilities.

In the case of cable model, the networks are generally hybrid fiber-coaxial (HFC) systems, using co-axial cable at the terminating points of the subscribers. Cable technology goes back to 1940 to the beginning of microwave transmission. On the other hand, fiber technology is twenty years old, having been used initially in cable backbone networks and then in telephony. Today, advanced fiber-optic technology makes it possible to provide a terabit per second, or a trillion bits per second, of capacity on a single strand of fiber!

As far as wireless technologies are concerned, the recent advent of “Wi-Fi” or 802.11 wireless capabilities have made it possible to have 2-5 Mbps speeds, albeit over very short distances of 100-200 feet. Wi-Fi represents a cost-effective and appealing solution to share broadband within small vicinity, like inside a home or business, or around an installed “hotspot”. However, it does not present itself as a pervasive broadband network solution for a town or even a neighborhood because of debilitating range and line-of-sight issues. In addition, there are severe capacity, security and scale problems with wireless technologies, which makes it an unsuitable medium for data, voice and video beyond highly localized applications.

4.1 *Benefits of MBN to the Municipality*

Municipal broadband systems can help communities retain current key industries and businesses by providing essential communication infrastructure. At the same time, a high bandwidth broadband network can attract businesses and jobs. The specific benefits are as follows:

Economic Development: Through offering high bandwidth networks cities can enhance the economic climate in their respective communities by attracting new businesses.

Community Preservation: Preserve industries and economic opportunities that may require access to high bandwidth networks to compete in the broader economy.

Essential Communication Services: Provide essential communication services to Public Safety, Educational Institutions and Hospitals. Increase access to essential medical services by facilitating links to regional medical and trauma centers.

Unify Community: Provide an advanced high bandwidth network throughout a community, offering opportunities for access to governmental and educational services.

Spark Competition: Create real competition in the area in cable telecommunication and Internet access and content business. Competition helps stabilize consumer prices, and offers greater choice and selection

Open Access: Provide an Open Access platform for service providers, content providers and Internet access providers to use.

² Copyright 2002, The Merton Group, all rights reserved.

Telecommuting: With a high bandwidth network in place, real telecommuting becomes an option, helping relieve road congestion, and offering flexibility for both employers and employees.

4.2 Practical Considerations

There are several practical considerations that much be addressed in the deployment of MBNs. They are:

Technology Selection: Setting goals for the network will help drive this selection. Will the network be the only one providing Internet connectivity? Will it be an advanced high bandwidth network taking fiber-to-the-home and curb? Will it be a dark fiber, condominium network, or regional wholesale network? Answers to each of these questions may dictate a distinct selection of technology, or blend of technology. However, because the local telephone and cable company currently use copper and hybrid fiber coaxial cable infrastructure, building a forward looking network with capability of expansion may provide the best solution and best competitive edge.

Financing and Debt: How will the municipality finance the network: public or private sources? Can it leverage its tax-exempt bonding authority to raise funding? Will the network generate sufficient revenues to cover bond debt service and operating expenses?

Customer Relations and Marketing: Is a municipal entity capable of providing the marketing of services to its customers? Can a municipal entity respond to the competitive pressures in the market place? Can a municipal entity take advantage of bulk purchasing, as well as packaging of network services? A number of these issues are mitigated if the municipality only builds the broadband infrastructure and does not get into the Internet, cable or telephone business.

Local Political Issues: How will the incumbent telephone company react? How will the incumbent cable company react? Does the community perceive the network as a threat to private business, or a key utility infrastructure to attract and retain businesses? Have the elected officials been fully briefed on what to expect from the incumbent operators? Are the incumbent operators partners in the venture?

Municipal owned and operated MBNs are considered by many to be the best alternative to:

1. Ensure open access.
2. Ensure retail competition and the innovation and reasonable service prices that go along with that.
3. Ensure the timely and ubiquitous deployment of true broadband services, particularly in communities and areas that lack the size and density to attract private capital investment.

The demand for MBN is predicated upon the requirement and requests from local residents, businesses and public institutions in a community who want a diversity of broadband services from very high speed Internet access (10-100 Mbps) to digital cable TV. This typically cannot be provided by existing copper or coaxial systems. Thus a re-build or overbuild is essential, and the MBN represents a solution.

4.3 The Network and Infrastructure

The overall network can be perceived in three steps; local network with generic boundaries, local network as an open infrastructure, interconnected open networks.

4.3.1 Local Network Interconnection

The MBN can be depicted as below. One end of the MBN, the head end, has an open interface suitable for interconnection to a variety of service providers. The interface is open to any and all, and is not proprietary in any fashion. The other end of the MBN has an interconnection to the home. The interconnection may also be to educational institutions, fire, police, libraries, municipal facilities, and to commercial entities as they may request. The network in-between the two interconnecting points is an optical fiber network with

drops of fiber to each subscriber. The fiber drops are provided on an as-requested basis. The network does not have to be deployed fully day one. It can be built out as demand warrants.

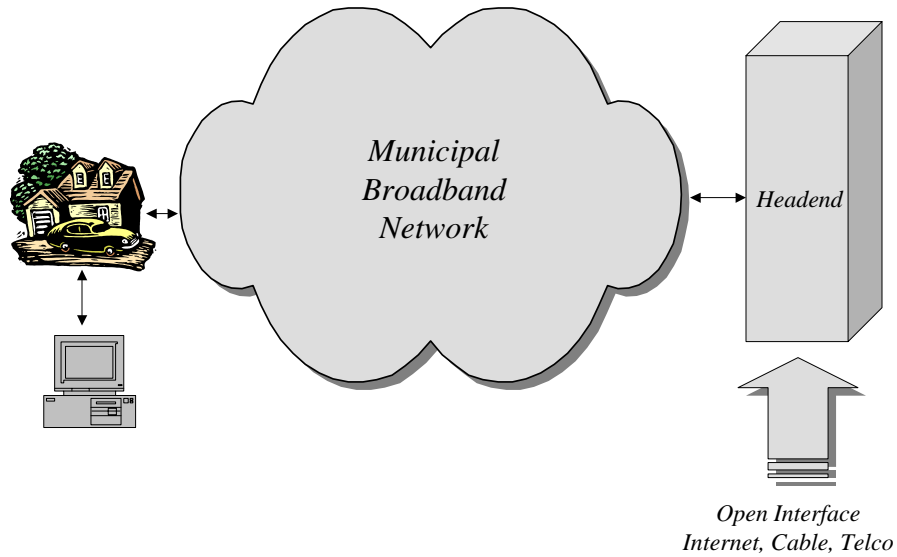

4.3.2 Local Open Networks

The following depicts the local openness of the network. Each user of the network can connect to any and all other local users via the IP capabilities of the network. Each connection to the network has an IP or IP addressable port. The connection is via ports, elements which can enable communications and interconnectivity between any user. The network is flat and open not hierarchical and closed. This is a key fundamental difference in network architecture design and implementation.

FTTU Open Access

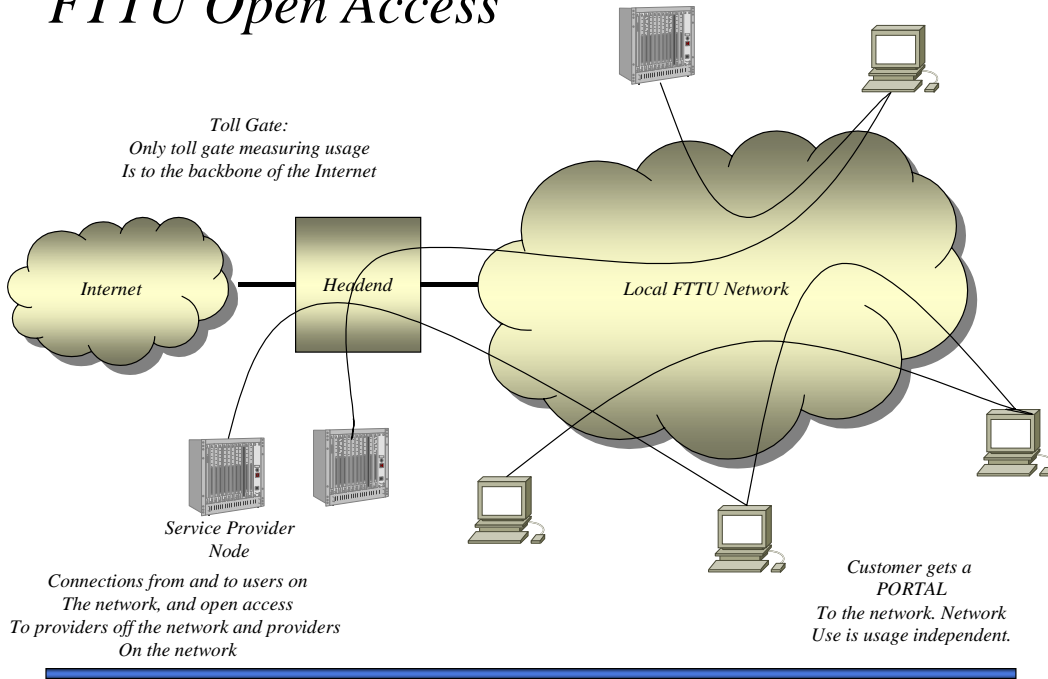

4.3.3 Interconnected Open Networks

The following depicts the interconnection of three regional MBNs. This interconnection is readily achievable via the use of the IP standard interface. Clearly some form of DNS, Domain Name Servers must also be employed and naming and address management will be an issue however the ability to interconnect at layer 3 is critical.

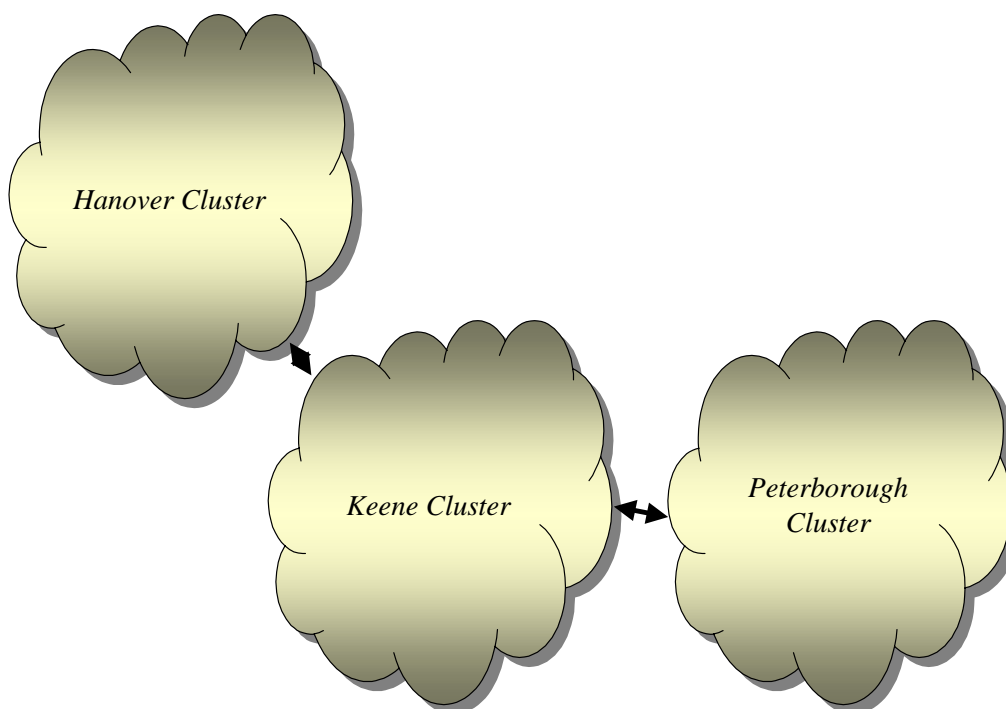

4.4 Service Providers and Services

The town deals with the service providers who in turn deal directly and separately with the subscribers. The service providers may fall within three or more categories. The basic three are:

Internet Service Providers: Typically this would be someone like AoL, msn (Microsoft), Earthlink, AT&T or Verizon. Typically, the customer already has a relationship on a dial up basis with that provider; it is the service provider's duty to move the customer to the MBN. Such agreements would have to be struck between the providers and the town and not the town and the customers. The ISPs could provide low speed (1-10 Mbps), medium speed (10-100 Mbps) or high speed (100-1000 Mbps) data services on the MBN, with varying pricing and service level (shared/dedicated), tailored to subscriber needs.

Cable TV / Dish Providers: The incumbent CATV provider may or may not want access to the MBN. Notwithstanding, the town may allow access to other CATV / dish providers. Also, ISPs like AoL and msn may themselves want to provide video services over the MBN, now that they have speed of data interconnection that supports high quality video. The network will be able to provide the user with access to analog and digitized video services. This may also enable the provisioning of interactive video services. The MBN will also support high definition TV (HDTV) services.

Telephone Providers: The alternative telephone carriers, including CLECs, may also want access. This network provides an open interface, which is highly conducive to other telephony options. The MBN system may be used to provide fully switched toll-grade quality voice service. In addition, the network may

support the emerging Internet Protocol (IP) phone technology, whereby, a user with an IP phone³ can dial another IP phone user anywhere else in the world who is also on a broadband network, for practically free!

The town that develops a MBN is responsible for the deployment of infrastructure, just as it does with sewer, water and possibly gas and electric. The town is the facilitator of an open utility for the people of the town, the facilitator of a service, which the town's citizens may avail. The town does not necessarily become the service provider, although it has the option to do so.

³ Manufactured by Cisco, Siemens et. al.

5. NETWORK LAYOUT

The network layout is based upon the constraints, performance, and to some degree upon the technology choice. The technology choice can be reduced to one of two types; PON, passive optical networking, and Giga Bit Ethernet, GigE. It has been shown elsewhere that they are both conceptually similar but have differing performance characteristics.

5.1 Design Constraints

The major design constraints are:

1. Total population: This is the total population of the town. The penetration of actual customers and their geographical distribution will be part of the market research effort. Moreover, there may be certain sections of the town, which are unreachable.
2. Total number of streets: The total number of served streets is critical. There may be large commercial areas or areas long in length, which are, not targets for the FTTH service. These must be identified. Commercial street locations may, however, be targets for commercial service provisions.
3. Frontage: The frontage is the average length of the front of a HH. It is a measure of local HH density. Large frontages may be an added cost to capital plant deployment.
4. Drop Lengths: The drop length is the distance from the point of the fiber on a pole to a local household. The drop may be aerial or buried. The nature of the buried fiber may also be a key cost element. Long drop lengths may be exceedingly costly.
5. Total Mileage: Total road mileage will be a key factor in the design. The “served” mileage will, however, be the driving factor.

5.2 Design Inputs

The following table depicts the key design inputs.

<i>Design Input</i>	<i>Implication</i>
Total Miles of Streets	This is the total street miles. It also requires a detailed analysis of what streets must be covered, a timing of the streets deployment and a preliminary discussion of commercial areas.
Total Number of Households	This is the total HH count. It is important to understand HH counts and user counts. Namely, there may be student or multiple HH residences.
Services Desired: -Broadband Internet Access -Video, Analog and Digital -Telephony	The actual services required must be factored into the overall design. This is a question of both service demand in size as well as timing. In addition, a detailed definition of the services will be required. This report focuses only on an IP supported infrastructure.

<i>Design Input</i>	<i>Implication</i>
Anticipated Location of Headend	The headend is “anticipated” to be at a certain location. Clustering of headends over multiple towns is also a strong possibility. This will be considered in detail in the later stages of the design process.
Streets Identified for Initial Build	The initial build streets must be identified for each quarter for the first two years. In this model, we have done so in a generic fashion. For the definitive model, this will need further work.
Percent Aerial Construction	This is a measure of the percent of fiber, which can be deployed on telephone poles.
Percent Buried / Trenched Construction	This is the percent of fiber, which must be buried.
Who Owns Poles and Aerial Rights of Ways?	The pole ownership must be clarified. Although not a key element of this study, it will be a key element in understanding the ultimate study results.
Who Owns Buried Rights of Ways?	This is the same set of issues as regards to pole rights.
Total Number Poles	This is the development of a data base of all poles, who owns them, where they are, what is on the poles, and an estimate of any and all make ready issues.
Average Distance Between Pole	This distance may be a standard for the town but should be understood at least on the sector level.
Pole Identification Numbers by Streets	This is the data contained in the pole database.
Average Setback of Homes	The setback is from the street but is typically measure from the nearest pole of buries access point. Thus setback is the gross effective setback measurement.
Known “Make-Ready” Issues	Make ready costs and times must be further understood. The model uses standard make ready costs for the region. Generally, these are consistent but must ultimately be reduced to a definitive number.
Is Electrical Space Available for Fiber Run?	The basic availability of space is a key issue. No space, no deployment. In most towns of interest, this is not a problem but must be ascertained.

5.3 Design Performance Issues

The following are the proposed performance factors for the design.

<i>Performance Factor</i>	<i>Measure</i>
Reliability	99.9%
Mean Time to Repair	< 2 hours
Delay or Latency of Packets	< 10 ⁻⁶ sec
Maximum Downlink Data Rate per HH	100 Mbps
Maximum Uplink data rate per HH	100 Mbps
Minimum Downlink Data Rate	10 Mbps
Minimum Uplink Data Rate	10 Mbps
Bit Error Rate	Less than 10 ⁻⁹

5.4 Design Methodology

The design methodology used in this study is intended for a feasibility study analysis and not a detailed design analysis. The basic elements are:

1. Sectorization of the network into sectors of generally comparable population and generally contiguous streets or accessibility.
2. Field evaluation of the frontage, set back, aerial percentages, make build costs, and drop availability using a photo database and sampling techniques is performed.
3. Data analysis of field information to develop a sectorized financial model.
4. Use of two basis technologies, PON and GigE, and using averaged industry pricing numbers for the development of a pricing model for all capital plant.
5. Overall, network optimizations and analysis using field data, vendor average price data, and optimized design methodologies for a capital plant deployment cost analysis.

6. ANALYSIS OF PLANT BUILD

This section details the basic design and analysis methodology. It must be repeated that this is a Feasibility study and not a detailed design study. It is most likely that any third party making a bid to perform the work discussed herein may have a different design and in addition, there may be added design factors that may not have been included herein.

Thus, the methodology chosen is used for feasibility analysis only.

6.1 Methodology

The methodology is composed of several elements. The approach consists of the following steps:

1. Establishment of Headend.
2. Sectoring the town. This step breaks the town into sectors of no more than 1,500 HH and has sectors with generally consistent characteristics.
3. Establish of the network elements.

6.1.1 Headend

The headend is the key location for the central interconnection of all inbound and outbound communications. The headend is selected for each tow although it may be possible to combine headend for common towns.

6.1.2 Network Elements

The network is a series of a bundle of fibers. A typical bundle may have upwards of 36 strands of fiber. The end goal is to have a strand or strand pair per HH. The ability to perform this interconnection is based upon the integration of three units; the CSU, the FSU, and the EEU. The CSU is the main interconnection point, the FSU is a branching and sharing point, and the EEU is in the household.

The network has the following elements:

Central Service Unit (CSU): This unit provides for the interconnection of any and all inbound and outbound communications. The unit had a fixed initial capacity, say 8,000 users, and variable capacity say 2,000 users per new unit element. These numbers will vary depending on the vendor. The CSU provides for interconnectivity of all services and its price and variability will depend upon the service mix. The CSU is in the headend.

Field Service Unit (FSU): The FSU interconnects a single or pair of fibers to multiple bundles of fiber. The fibers coming from the CSU are carrying a high-speed data backbone service of 1 Gbps or greater in both directions. The FSU then shares this amongst multiple outbound fiber bundles. The FSU has a fixed cost element for a minimal number of outgoing fiber bundles and a variable amount. In addition, the FSU has a maximum capacity of outgoing fiber bundles. The FSU is a branching element, which “shares” the bandwidth or data rate on the backbone with all end users on the final terminating leg. This is generally the bottleneck in any network. In PON designs, this is fixed and in GigE, this can be dynamically managed.

End User Unit (EEU): The EEU is the household interconnection device. It connects to the fiber or fiber pairs and then to the in home Internet access, telephony, or video.

The typical network is shown below:

Basic Architecture

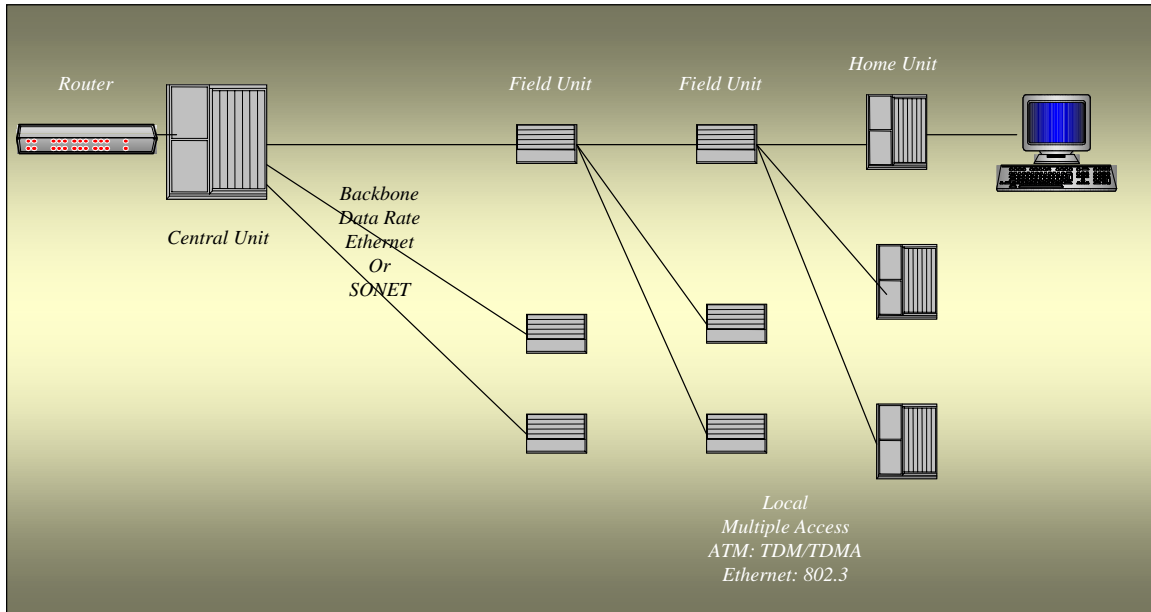

6.1.3 Sectorizing

Sectorizing is based upon two factors:

1. Maximum capacity per single fiber bundle.
2. Commonality and clustering of proximate neighborhoods.

As stated above, the FSU has a maximum capacity. This again depends upon the specific vendor and technology. However, this means that sectors must be no larger than a single FSU capacity. The design initially starts with 50% or less maximum loading per sector. It should be noted that new sectors can be added at any time if additional capacity is required.

The second issue is that the sectors should have some commonality in terms of end users; household since, setback, frontage, aerial or otherwise, or other similar factors.

6.1.4 Network Layout

The network is deployed with an initial deployment of a fiber bundle to each sector, which connects to an FSU in each sector.

The three elements are shown below. They figure generally depicts the three elements of trunk, feeder and drop. The financial model uses this nomenclature and build costs elements.

Generic Fiber Network Elements

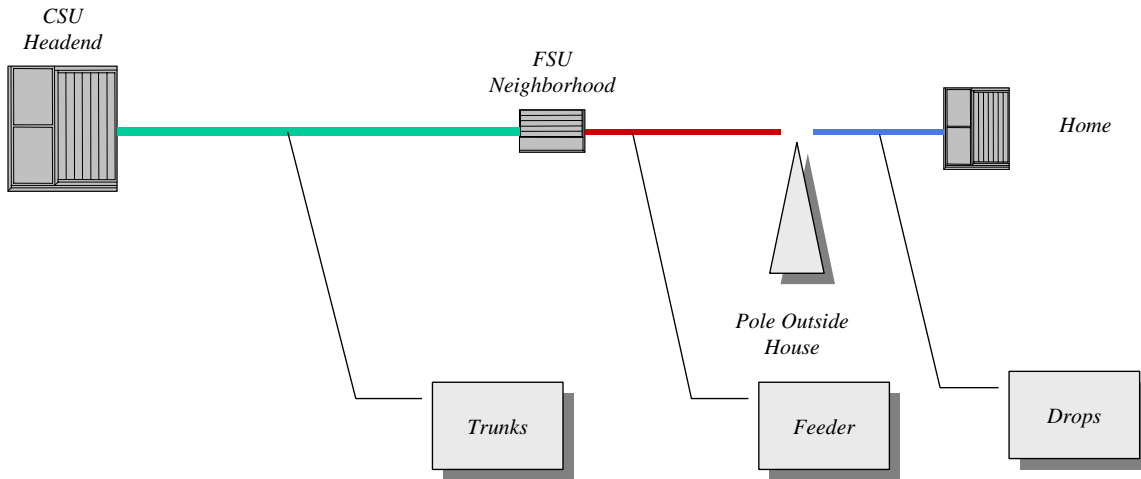

6.1.4.1 Trunking

Trunks are from the headend to the FSU. They are the high speed backbone elements of the network. The general scheme is a trunk is co-located with a sector. There may be more than one trunk per sector, however. In the initial designs a trunk and a sector are unique. The trunk has 48 fiber bundles, each fiber going to a FSU. The trunk may be most likely aerial. It will typically follow a major road but that will often be determined by the make ready costs associated with the poles on that route.

6.1.4.2 Feeders

From each FSU to each home there is a set of feeder cables. The feeders are sets of bundles emanating from a FSU. The number of bundles and in turn the number of feeder cables will depend on technology but multiple ones are possible. Thus with a 48-strand trunk, and having a minimum of say 2 feeder per FSU, one can achieve 2X48X48 HH to be served, or 4,608 HH with that design alone.

6.1.4.3 Drops

The drops are the strands from the feeder to a single household. The drops are measured in what is termed set back distances. Whereas the trunks are typically 10-20% of the total road mileage, and the feeders make up the rest, the drops may become a significant additional set of build if the build requires large set back distances.

6.2 Results

This subsection details the overall design based on the field analysis. On March 31, 2003, the Merton team made field analysis of all of Peterborough (Extended). The town was sectored and each sector had a drive through. Data were recorded both quantitatively as well as with images. The image date is shown in the final section of this report.

6.2.1 Sector Design

The following figure depicts the Peterborough sector map. The town was divided into 5 sectors. They are shown on the map, which is contained in the following.

Based upon the field analysis, the following map shows the network trunk network design. Feeders are then brought out to serve the remainder of the sectors.

Peterborough has no sectors.

The mileage for each of the runs was obtained and shown as follows:

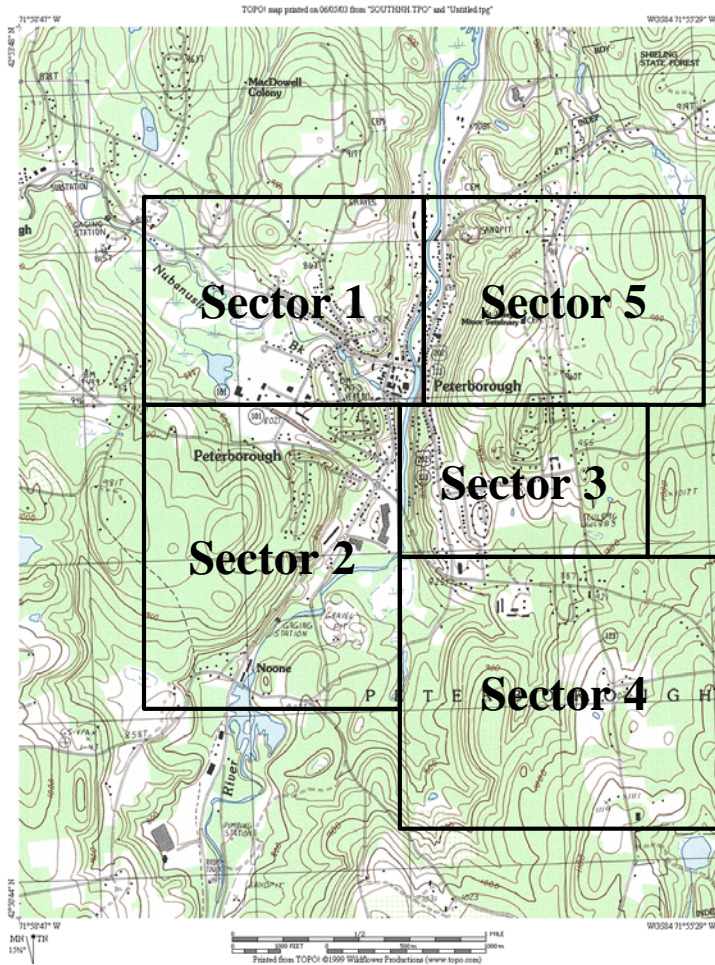

6.2.2 Basic Network Build Data Analysis

The following data depicts the network summary data for each sector. The raw data is contained in the end of this report.

The first table, shown below, depicts the overall breakout for the town. It is an estimated population and street mile count per sector. These numbers will be used with the field data to estimate the sector setback, aerial and make ready requirements. It is important to reiterate that the data are samples with feasibility

6.2.5 *Make Ready*

A similar analysis has been performed on the make ready amounts. Significant make ready is required in some areas. However, the overall make ready is less than 13%.

Sector	Street Miles	Average Make Ready	Weighted Make Ready
1	36	32%	12%
2	23	5%	1%
3	22	0%	0%
4	12	0%	0%
5	13	16%	4%

Total Average Make Ready 16%

6.2.6 *Aerial*

The amount aerial has also been calculated. The town is mostly aerials so the requirements for buried are minimal.

Sector	Street Miles	Average Aerial	Weighted Average Aerial
1	36	100%	37%
2	23	86%	13%
3	22	100%	17%
4	12	100%	7%
5	13	100%	24%

Total Average Aerial 98%

7. SYSTEM DESIGN

This section is a brief overview of the technology deployed in the case of MBN.

7.1 System Elements

The basic architecture for PON or Gigabit Ethernet is shown below. The elements are:

1. **Central Unit:** This is at a headend or some similar central location and provides for central management and interface.
2. **Field Units:** These units are the n:1 splitting devices, active or passive, which take a backbone signal and share it amongst several home units. In GigE the backbone rate is 1 Gbps down and up using two fibers, in ATM PON it is a single fiber using several wavelengths, one up and one down, using SONET and ATM formats. SONET is a layer 1 protocol.
3. **Home Units:** These are the devices in the home made to support data, voice, and video.

Basic Architecture

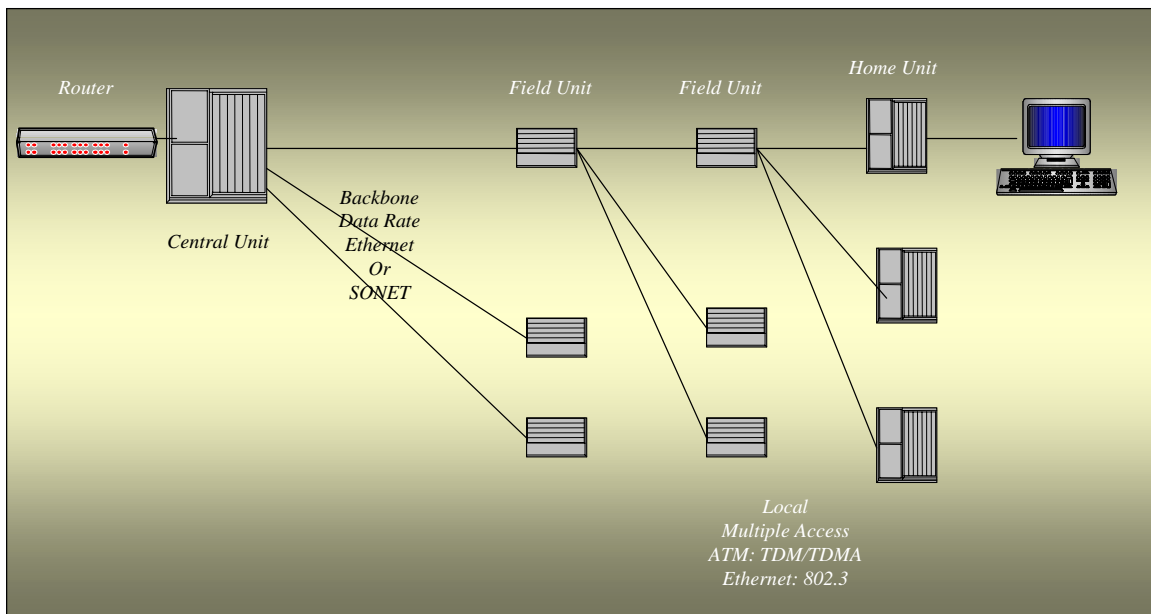

This section briefly overviews various architectures. The key point is that whatever the local architecture, it is critical for openness and scalability to follow a minimalist approach with common protocols and interfaces. This drives the IP direction. In effect, each acceptable architecture and its embodiment must be able in a ready fashion to interconnect to other networks while at the same time permitting local access between and amongst all its users.

7.2 Broadband Network Architecture

This section presents an overview of the technology of FTTH. It is a fiber connection that currently provides capacity from 100 Mbps to 1 Gbps to each user using Gigabit Ethernet or Passive Optical Network technology. FTTH can be easily upgraded as technology changes; only the electronics need to be supplemented/replaced and not the physical fiber, which has a life of over 20 years. Electronics usually

form only about 20% of the cost of a fiber network, therefore, incremental upgrades are not expensive. Standards for 10 Gigabit Ethernet is already being worked out. Therefore, it does not seem likely that FTTH technologies will suffer from obsolescence in the medium to long term.

7.2.1 Popular Broadband Network Designs

There are multiple network designs that can be used to deploy local fiber broadband services via fiber to the home (FTTH). The factors that control what speeds are provided are the technology components that are installed at the end points of the fiber network; the residence/business and the service provider's Point of Presence (PoP), which may be the head end, local hub or Central Office (CO). The main forms of FTTH architecture are the following:

(i) *"Home Run" systems*: a separate fiber or fiber pair runs all the way from each home/business to the PoP. In this design, there is no sharing of fiber; therefore, this offers the ultimate performance with the most flexibility. Independent providers can deploy technology of their choice with minimal compatibility and interoperability issues. In addition, the end-point equipment attached to each fiber can be independently upgraded. However, the costs of installation of this design are usually prohibitively high and are overkill in terms of performance capabilities.

(ii) *Passive Optical Network (PON) systems*: a single fiber or fiber pair runs from the head end to a passive optical splitter that is located at a local hub (also called a remote terminal or just "remote"). Single strands of fiber then run to a group of homes or individual homes or businesses. The optical splitters are quite compact and simple. The absence of active electronics in the field and the simplicity of design yield lower life cycle costs. In addition, the passive nature of the optical splitters avoids the need to have power systems at the remotes, thus increasing the reliability of the entire system. In addition, overall maintenance costs are reduced. The disadvantage of this design is that terminal and head end equipment may have to be simultaneously upgraded to ensure compatibility and interoperability. Capacity may be constrained in the upstream circuits, which become shared resources.

(iii) *Fully Active Electronic Equipment At Remotes systems*: in this architecture, fiber runs from the head end to one or more stages of remote terminals at which the signals are switched among fibers that then feed individual premises. Ethernet switches are typically used at the remotes. The primary disadvantage of this design is the need to have robust power systems and some real estate at the remote terminals. However, this generally yields a system that is not much more expensive in the long run compared to the PON architecture, and provides much more flexibility to service providers in delivering varying level of services to end-users and guaranteeing QoS; this system is also most easily upgradeable for technology changes.

Fiber-optic technology, offering virtually unlimited bandwidth potential, is widely considered to be the ultimate solution to deliver broadband access to the last mile. Today's narrowband telecommunications networks are characterized by low speed, service-provisioning delays, and unreliable quality of service. This limits the ability of a consumer to enjoy the experience at home or the ability of workers to be efficient in their jobs. The last mile is the network space between the carrier's central office (CO) and the subscriber location. This is where bottlenecks occur to slow the delivery of services. The subscriber's increasing bandwidth demands are often unpredictable and challenging for telecommunications carriers. Not only must carriers satisfy today's bandwidth demands by leveraging the limits of existing infrastructure, they also must plan for future subscriber needs.

7.2.1.1 Network Elements

A new network infrastructure that allows more bandwidth, quick provisioning of services, and guaranteed quality of service (QoS) in a cost-effective and efficient manner is now required. Today's access network, the portion of a public switched network that connects CO equipment to individual subscribers, is characterized by predominantly twisted-pair copper wiring.

The following Figure depicts the generic approach to the deployment of broadband electronics in a FTTH system. It is composed of four elements:

1. **Head End:** This may or may not be in a town and can serve one or several towns. There is significant scalability in head ends and these are point of presence or interconnection for service providers or the backhaul systems which connects to service providers.
2. **Hubs:** These are town located and generally central facilities which represent the specific town's point of presence. It may be at some convenient town location such as a police facility, fire department location, town hall or the like. It is the point at which the backbone fiber network connects to the system
3. **Sub-Hub:** These are the units in the field which allow for branching. There may be one or several levels of sub hubs. The sub hub provides a 1:N branching or splitting of the signal, and this may be done at several points allowing for a 1:N^m multiplication of backbone fiber to customer connection.
4. **Home Unit:** This is the device in the home. It provides for a broadband internet connection of 10-100 Mbps, a telephony connection and a CATV or digital video connection, using all existing home wiring.

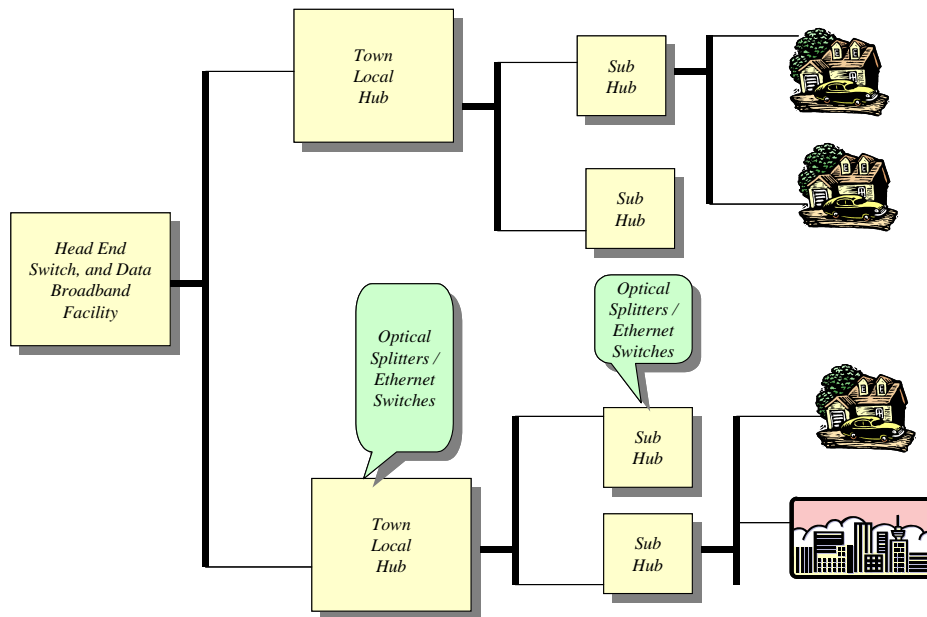

The basic architecture for local PON or Gigabit Ethernet is shown below. The elements are:

4. **Central Unit or Hubs:** This is at a headend or some similar central location and provides for central management and interface.
5. **Field Units or Sub Hubs:** These units are the n:1 splitting devices, active or passive, which take a backbone signal and share it amongst several home units. In GigE the backbone rate is 1 Gbps down and up using two fibers, in ATM PON it is a single fiber using several wavelengths, one up and one down, using SONET and ATM formats. SONET is a layer 1 protocol.

6. Home Units: These are the devices in the home made to support data, voice, and video.

Basic Architecture

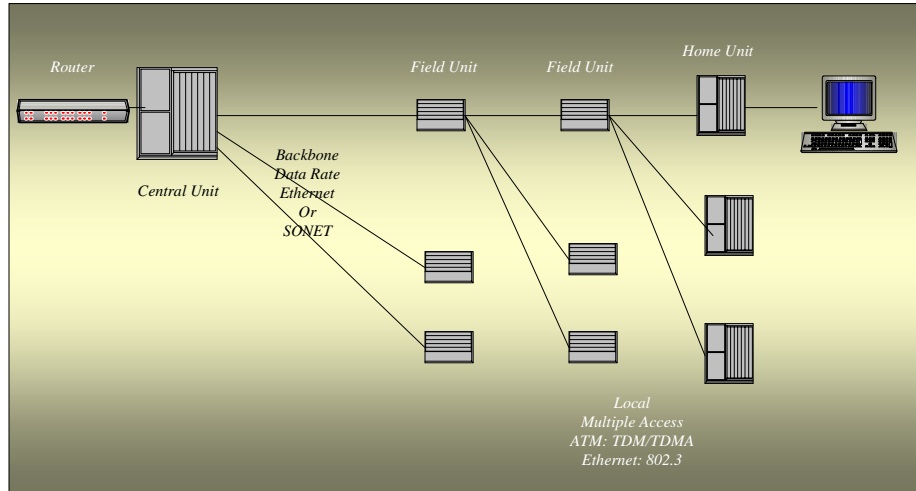

In general, the optical section of a local access network can either be a point-to-point, ring, or passive point-to-multipoint architecture.

As these components are ordered in volume for potentially millions of fiber-based access lines, the costs of deploying technologies such as FTTH, FTTB/C, and FTT/Cab become economically viable. One optical-fiber strand appears to have virtually limitless capacity. Transmission speeds in the terabit-per-second range have been demonstrated. The speeds are limited by the endpoint electronics, not by the fiber itself.

Telecommunications equipment vendors offer service providers a number of broadband access technology platform choices, but an access technology solution must be capable of providing:

- Multiple voice, data and video services
- Reliability consistent with expectations of customers
- Low cost and price-competitive operations
- Network scalability to meet expanding demands for bandwidth
- New, differentiable services that enable high margin revenue sources

The proliferation of fiber combined with advances in optical technology positions GigE technologies as an ideal broadband access platform. This is particularly true for serving small to medium business customers. GigE offers ILEC/PTT service providers a cost effective and virtually unlimited bandwidth access platform capable of supporting legacy voice and data services.

In addition, because GigE supports multiple Ethernet/IP, ATM, and/or TDM services, GigE delivery platforms can uniquely support the introduction of new, bandwidth intensive enhanced services without costly upgrades.

The other issues are about whether the fiber cables should be pole-mounted or buried (trenched). Pole-mounted is generally less costly, but is potentially subject to delays in obtaining access depending on current configuration of existing telecom, cable TV and power system cables on the poles. However, in most cases, this “make-ready” process of reconfiguring existing cables on poles may not be an issue. Buried fiber may be more expensive but could be less of a delay depending on pole “make-ready” requirements, and has somewhat less life cycle maintenance.

The above electronics shows the element breakout. From the Hub Remotes the end derive is the in home element. These are individually installed and require interconnection in the home.

7.3 PON vs. Gigabit Ethernet

This section is a more detailed presentation of the elements of the communications infrastructure. It is a high level view of the communications elements which are part of the overall network design and operations.

The first step is to understand that there are two major options: PON or passive optical networks and Gigabit Ethernet, GigE.

1. PON is a passive technology which “splits” signal in a set of passive optical splitters, allowing each residence to have a share of the data link. PON uses one of several transmission characteristics on the link, typically an Ethernet format can be used on the backbone allowing for full bandwidth utilization and IP at the end points.
2. GigE uses active splitters which provide Ethernet as the transmission approach all the way throughout the network. The use of Ethernet protocols on the backbone are the differentiators. Again IP is used at the end points.

PON has passive non powered field units and GigE uses powered intelligent devices. We now present some high level discussions on protocols and then on each technology. The key difference in PON versus active is that PON has no active devices in the network and lacks a level 2 switch embedded. The distance of PON is generally smaller, about 10-15 mi radius. There are hybrids of the two which can be combined to meet the needs of a diverse environment.

7.3.1 Protocols

Protocols are agreed to standards for the purpose of establishing communications between two or more computers. The development of protocols has been significant ever since the development of computer communications in the mid 1960s with Project Multics at MIT. In that project the intent was to have large university computers talk with each other. This evolved into the AREA Net, which is the predecessor in an evolutionary fashion of the Internet. In 1974 Kahn and Cerf proposed a protocol called TCP/IP. This was a packet based protocol for communications. It was different that the X.25 protocol used by the Europeans and the larger networks in the US which was a very overhead intensive protocol.

In the late 1970s Clarke at MIT and Cerf now with Kahn in CNRI created an operational basis for TCP/IP. It became the backbone protocol of the AREA Net, using the IETF, Internet Engineering Task Force, as the “club” to make it a reality. In the late 80s AREA Net spilt into commercial and government, the commercial is what we now call the Internet.

In the mid 70s, IBM proposed and pushed with the ISO, the International Standards Organization, a seven layer protocol. The IBM version was SNA, System Network Architecture, the ISO version was a bit more complex in certain areas. The following figure presents the seven layers and their proposed functions. The performance, costs, expandability, scalability, and many other factors are highly dependent on the protocol set chosen. In this report we focus on layer 2 and 3, and the two choices are PON and Gigabit Ethernet, each has advantages and disadvantages, both are separated at layer 2.

Protocol Layers

Application	<i>The applications software, it is what the end user sees and uses.</i>
Presentation	<i>Provides for such things as security and security management.</i>
Session	<i>Controls communications between applications, flow management, and creates sessions between applications at end user level.</i>
Transport	<i>Ensures reliable end to end transport and flow control</i>
Network	<i>Provides point to point and point to end point reliable links</i>
Data Link	<i>Provides for reliable physical link transport; can be divided into LLC and MAC functions</i>
Physical	<i>Provides physical connections and electrical connections, including modulation.</i>

7.3.1.1 TCP/IP

TCP/IP is the key protocol used in the Internet. It is a protocol which is what is called a “best efforts” approach to telecommunications. In effect, it takes a set of headers, TCP and IP, and then attaches a data packet, a packet of variable length. It then sends this over a network and “hopes” that it gets there. In the early days it was stated, “every packet was an adventure”. It has been learned however that the basic networks are highly reliable so lost packets are not a serious problem, packet delays may be a very serious one, depending on the network traffic.

7.3.1.2 ATM

ATM is a telephone based packet. It differs from TCP/IP in two key ways; first, it is a fixed length and does not vary as data requires, you send a fixed length frame whether you need it not, second, there is large overhead to ensure quality of service requirements so that loss and delay can be guaranteed in some specified limits. ATM is a telephone mindset, IP is a computer.

Now ATM is a layer 2 protocol, it is what is below IP and IP is below TCP; this is in reality a concatenation of overheads, each with their own functions. ATM frames have lots of overhead for such things as quality control and services level administration. ATM was built by telephone people not computer people, it was a higher speed way to interconnect telephone switches as we knew them in the early 1990s. It did not anticipate such things as IP telephony.

ATM is a telephone based format. In addition to the fixed frame size, whether used or not, it also had selected data rates, OC 1 as 45 Mbps, OC 3 as 155 Mbps, OC 12 as 622 Mbps, and OC 48 as 2.5 Gbps. It is possible to put IP on ATM, since ATM is layer 2 and IP is layer 3 and TCP layer 4. Thus, as has been done, TCP/IP rides on top of ATM.

7.3.1.3 Ethernet

In contrast to layer 2 ATM networks, there is a layer 2 computer protocol called Ethernet, and TCP can ride on this as well. Ethernet, albeit older than ATM, is truly a packet approach. It anticipates full flexible packet capabilities. The following is the layer 2 level of Ethernet, as specified by the IEEE 802.3 standard. Ethernet at layer 1 uses 10 Base T and 100 Base T forms of 10 Mbps and 100 Mbps. Also the signalling is CSMA/CD. Carrier sensed multiple access with collision detection.

7.3.2 Interconnectivity

These network schemes can be laid out in the following categories. It must be remembered that TCP is layer 4, IP layer 3, and Ethernet and ATM both layer 2. Thus we must consider connecting ATM to ATM, Ethernet to Ethernet, and then having TCP/IP riding on top of either. We show this in the following figure.

Ethernet Layer 2, 3 and ATM

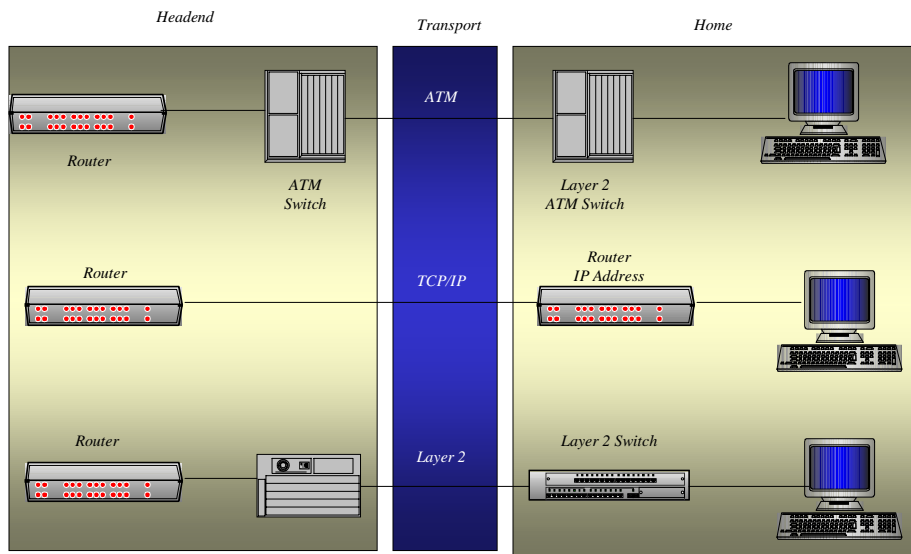

The Merton Group

© Copyright The Merton Group, LLC

Page 13

The difference between ATM and Ethernet is best shown below. They both have the same architectural elements; some central device, some filed unit for distribution, and some end user interface. However the difference are significant:

1. Data Size: ATM is fixed frame format Ethernet is variable
2. Field Unit: ATM uses PON and is passive, Ethernet is an active level 2 switch.
3. Distance: ATM using PON has range limits and Ethernet has extended range. This may or may not be a problem.
4. QoS: ATM allows QoS so that video can be guaranteed via central control, Ethernet uses IP based flow control and has QoS "engineered" via over capacity
5. Data Rates: ATM is fixed in SONET frames whereas Ethernet is highly scaleable and flexible.

Fiber Rates ATM v GigE

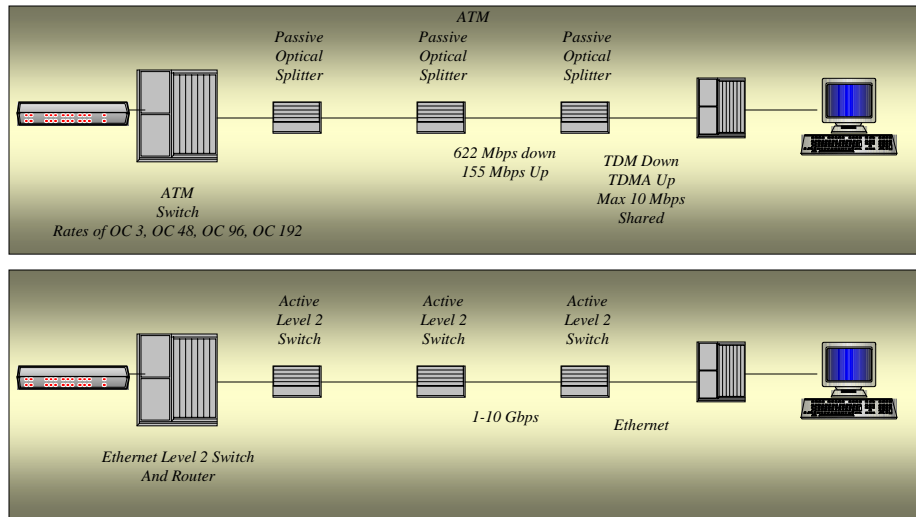

The Merton Group

© Copyright The Merton Group, LLC

Page 14

There are, however, several versions of PON technology. The multiple ways of implementing PON are;

1. APON - ATM PON—first commercial product, used primarily for business applications
2. BPON - Broadband PON—expanded version of APON with added functionality to support robust video services
3. EPON - Ethernet PON—PON using Ethernet for packet data - still evolving
4. GPON - GigaPON—evolving PON technology at gigabit rates
5. Proprietary PON—long term viability and support issues

We depict an E PON design below. We use Ethernet protocol as the down link and up link. Down link is TDMA with each user having as much capacity as it may demand at any one time, and on the up link from the ONU each user can demand as much but must contend with Ethernet like collisions. IP sits atop of this layer 2 protocol.

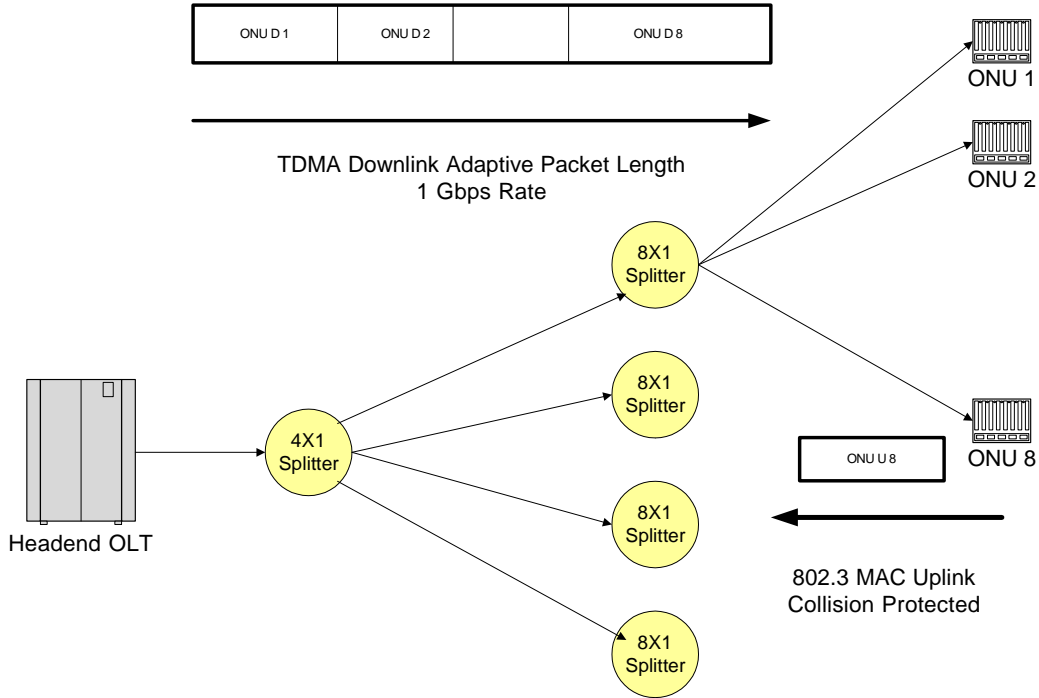

In general, the optical section of a local access network can either be a point-to-point, ring, or passive point-to-multipoint architecture. This tutorial focuses on the passive point-to-multipoint architecture (PON). The main component of the PON is an optical splitter device that, depending on which direction the light is traveling, splits the incoming light and distributes it to multiple fibers or combines it onto one fiber. The PON, when included in FTTH/B architecture, runs an optical fiber from a CO to an optical splitter and on into the subscriber's home or building. The optical splitter may be located in the CO, outside plant, or in a building. FTTH architecture runs an optical fiber from the CO to an optical splitter and then on to the neighborhood cabinet, where the signal is converted to feed the subscriber over a twisted copper pair. Typically, the neighborhood cabinet is about 3 kft from the subscriber's home or business. The maximum distance from the headend to an ONU is determined by an optical link budget loss of no more than 23 dB. This means 10-12 miles maximum radius.

8. CAPITAL PLANT ESTIMATES

We can now apply these models to a E PON example. The following is an expanded version of the basic architecture applied to the E PON solution. We have detailed the fixed and variable elements.

8.1 Fiber Network Costs

The fiber costs are based upon a per foot cost element for comparable market deployments. The following table summarizes the key input assumptions to those cost elements, which are used in the model. The details of the model have been show previously.

Element	Unit Cost
Aerial Engineering. + Construction Labor Cost per Foot	\$3.00
Trenching Engineering. + Construction Cost per Foot	\$8.00
"Make-Ready" Placement Cost per Foot	\$4.00
Fiber/Cable Material Cost per Foot - 2 Strands	\$0.10
Fiber/Cable Material Cost per Foot - 24 Strands	\$0.60
Fiber/Cable Material Cost per Foot - 36 Strands	\$0.70
Fiber/Cable Material Cost per Foot - 48 Strands	\$0.80
Fiber/Cable Material Cost per Foot - 96 Strands	\$1.00

8.2 Electronic Costs

The following demonstrates the detailed electronic elements and interconnections for the above basic architecture. The backbone is 1 Gbps active transport using 2 fibers per field unit, in this case called a hub.

The cost elements for an E PON are summarized in the following charts. These are representative costs for the total network elements. Also shown are the capacities, maximum and minimum and the fixed and variable costs factors.

8.3 Capital Summary

The following Table depicts the capital per subscriber for fiber, electronics and total.

CAPEX per HH vs Number HH (PON)

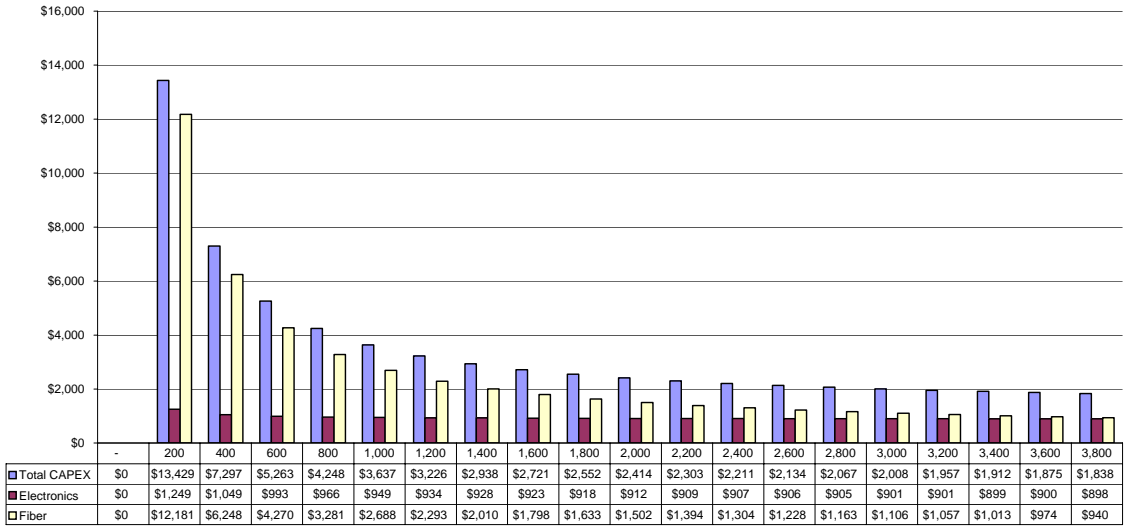

9. FIELD DATA

Town: Peterborough, NH
 Date: 6/10/2003
 Engineer: McGarty & Typadis

Total HH: 2,346
 Total Miles Streets: 106

Photo	Sector	Avg Set Back	Average Frontage	Aerial	Make Ready
1	1	100	100	100%	100%
2	1	100	100	100%	100%
3	1	100	100	100%	100%
4	1	100	100	100%	100%
5	1	100	100	100%	100%
6	1	100	100	100%	100%
7	1	100	150	100%	100%
8	1	100	150	100%	0%
9	1	100	150	100%	0%
10	1	100	150	100%	0%
11	1	100	150	100%	0%
12	1	200	400	100%	0%
13	1	200	400	100%	0%
14	1	200	400	100%	0%
15	1	200	400	100%	0%
16	1	200	200	100%	20%
17	1	200	200	100%	20%
18	1	200	200	100%	20%
19	1	200	200	100%	20%
20	1	200	200	100%	20%
58	1	150	200	100%	20%
59	1	150	200	100%	20%
60	1	150	200	100%	20%
61	1	150	200	100%	20%
62	1	150	200	100%	20%
63	1	150	200	100%	20%
64	1	200	400	100%	0%
65	1	200	400	100%	0%
66	1	200	400	100%	0%
36	2	150	250	100%	0%
37	2	150	250	100%	0%
38	2	150	250	100%	0%
39	2	150	250	100%	0%
40	2	150	250	100%	0%
41	2	100	200	0%	0%
42	2	100	200	0%	0%
43	2	200	250	50%	0%
44	2	200	250	50%	0%
45	2	150	250	100%	0%
46	2	150	100	100%	0%
47	2	150	100	100%	0%
48	2	150	100	100%	0%
49	2	150	100	100%	0%

Proprietary

50	2	150	100	100%	0%
51	2	150	200	100%	50%
52	2	150	200	100%	50%
53	2	200	250	100%	0%
54	2	200	250	100%	0%
55	2	200	250	100%	0%
56	2	200	250	100%	0%
57	2	200	250	100%	0%
29	3	250	400	100%	0%
30	3	250	400	100%	0%
31	3	250	400	100%	0%
32	3	250	400	100%	0%
33	4	500	1,000	100%	0%
34	4	500	1,000	100%	0%
35	4	500	1,000	100%	0%
21	5	200	300	100%	25%
22	5	200	300	100%	25%
23	5	200	300	100%	25%
24	5	200	300	100%	25%
25	5	200	300	100%	25%
26	5	250	400	100%	0%
27	5	250	400	100%	0%
28	5	250	400	100%	0%

10. DETAILED FIELD PHOTOS



P6100001.JPG
6/10/2003



P6100002.JPG
6/10/2003



P6100003.JPG
6/10/2003



P6100004.JPG
6/10/2003



P6100005.JPG
6/10/2003



P6100006.JPG
6/10/2003



P6100007.JPG
6/10/2003



P6100008.JPG
6/10/2003



P6100009.JPG
6/10/2003



P6100010.JPG
6/10/2003



P6100011.JPG
6/10/2003



P6100012.JPG
6/10/2003

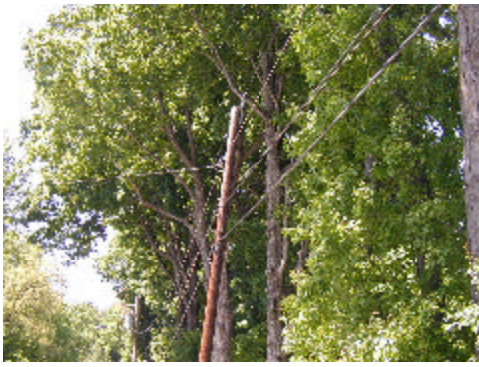

P6100013.JPG
6/10/2003



P6100014.JPG
6/10/2003



P6100015.JPG
6/10/2003



P6100016.JPG
6/10/2003



P6100017.JPG
6/10/2003



P6100018.JPG
6/10/2003



P6100019.JPG
6/10/2003



P6100020.JPG
6/10/2003



P6100021.JPG
6/10/2003



P6100022.JPG
6/10/2003



P6100023.JPG
6/10/2003



P6100024.JPG
6/10/2003



P6100025.JPG
6/10/2003



P6100026.JPG
6/10/2003



P6100027.JPG
6/10/2003



P6100028.JPG
6/10/2003



P6100029.JPG
6/10/2003



P6100030.JPG
6/10/2003



P6100031.JPG
6/10/2003



P6100032.JPG
6/10/2003



P6100033.JPG
6/10/2003

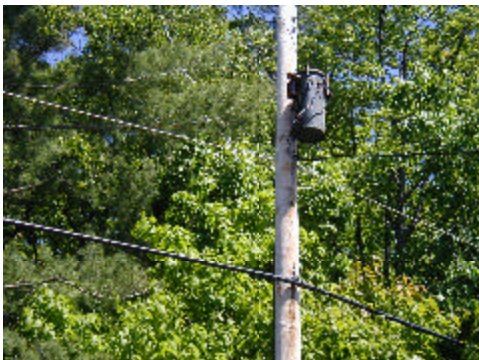

P6100034.JPG
6/10/2003



P6100035.JPG
6/10/2003



P6100036.JPG
6/10/2003



P6100037.JPG
6/10/2003



P6100038.JPG
6/10/2003



P6100039.JPG
6/10/2003



P6100040.JPG
6/10/2003



P6100041.JPG
6/10/2003



P6100042.JPG
6/10/2003



P6100043.JPG
6/10/2003

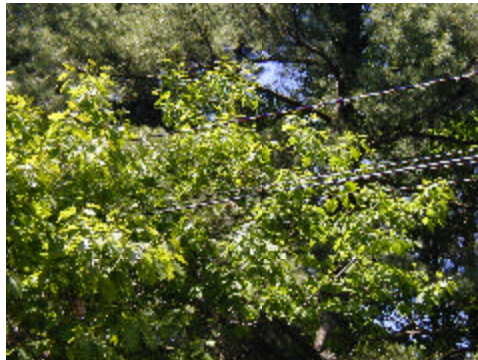

P6100044.JPG
6/10/2003



P6100045.JPG
6/10/2003



P6100046.JPG
6/10/2003



P6100047.JPG
6/10/2003



P6100048.JPG
6/10/2003



P6100049.JPG
6/10/2003



P6100050.JPG
6/10/2003



P6100051.JPG
6/10/2003



P6100052.JPG
6/10/2003



P6100053.JPG
6/10/2003



P6100054.JPG
6/10/2003



P6100055.JPG
6/10/2003



P6100056.JPG
6/10/2003



P6100057.JPG
6/10/2003



P6100058.JPG
6/10/2003



P6100059.JPG
6/10/2003



P6100060.JPG
6/10/2003



P6100061.JPG
6/10/2003



P6100062.JPG
6/10/2003



P6100063.JPG
6/10/2003



P6100064.JPG
6/10/2003



P6100065.JPG
6/10/2003



P6100066.JPG
6/10/2003